

Consider the 'inside-out' approach to optimize distillation operations

Economic value can be obtained by involving heat exchanger and tower internal experts in the initial design development

D. REMESAT, Koch-Glitsch Canada LP, University of Calgary, Alberta, Canada

The "inside-out" approach begins at the heart of the separation process—the distillation column—and works outward to the supporting equipment. This methodology focuses on column sizing/design (Fig. 1) and then moves up/outward within the processing unit and equipment. A recycle step is added to involve input from equipment experts on the process design and equipment selection and sizing.

The "out" in inside-out also refers to the expertise of equipment vendors. Their vast experiences provide significant value as demonstrated in the following examples.

Traditional vs. nontraditional column design. Many designers will argue that the column design is an early milestone and that appreciable recycle is provided in designs. However, with tight schedules and rushes to book long-lead items (i.e., vessels), the reality of using an inside-out approach is rarely followed. Tower internals and heat exchange comprise a small part of a project's cost; typically, this equipment is not included on the critical path list. Column and heat exchanger sizing are placed at the end of the design queue. **Result:** The opportunity for optimization is minimized since, at this point, the equipment expert is given a specified duty to design an exchanger, or given specified liquid and vapor flowrates to design the tower internals in a set diameter.

Proven or standard design and safety margin is the justification for not embracing the experience from the third-party equipment expert. The significant process and mechanical benefits captured from an inside-out approach (process and mechanical) far outweigh the additional investment.

Obtainable benefits. Process benefits are realized by capturing energy efficiencies and/or increasing product yield through:

- Embedding detailed equipment characteristics into process simulation (vs. typical rules of thumb)
- Applying flowsheet topology improvements
- Seeking column-staging optimization.

Mechanical benefits can be determined by incorporating the appropriate considerations by:

- Using specifications developed from operating, construction and shutdown experience
- Applying modularization to simplify field work.

These process and mechanical benefits are obtainable by following the inside-out approach as shown in Fig. 2. Once the initial economic objectives, cycle screening and simulation are

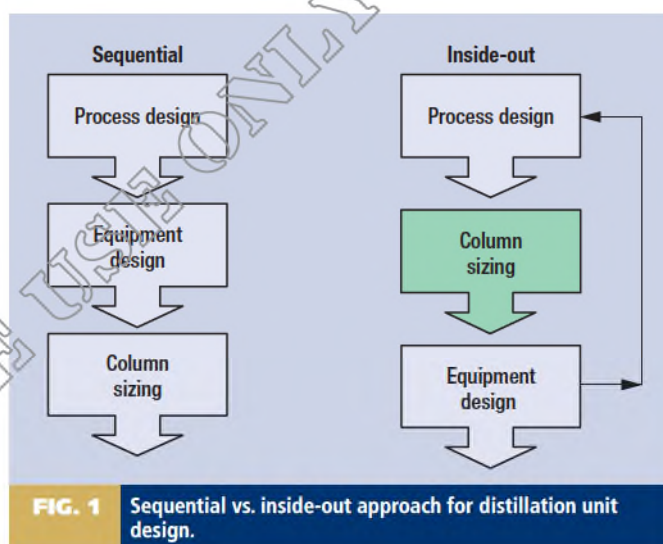

FIG. 1 Sequential vs. inside-out approach for distillation unit design.

developed, the steps highlighted in green apply detailed input from an equipment expert to build the equipment scope from the inside (distillation process) out. The process evaluation continues to ensure that no equipment envelopes are violated with any necessary iterations done.

The key to making this approach successful is finding an available in-house expert or a vendor with a life cycle approach that is willing to provide the necessary scoping support. The following examples validate that the search for an equipment expert to assist in the initial design phase is well worth the effort.

A&V unit grassroots design. Two examples involve new designs for an atmospheric and vacuum unit processing heavy synthetic Canadian crude. In particular, for the vacuum column, significant value (capital and operating) was obtained from fully incorporating the performance benefits of the tower internals, and supporting equipment into the process design (via simulation). Examples of equipment that can impact how a process design develops are:

- Feed inlet device—radial enhanced vapor horn—maximizes open area and reduces entrainment potential²
- Grid/packed combo wash bed section—mitigates fouling and optimizes heat transfer
- Spray distributors—mitigates fouling and enables ample wetting coverage

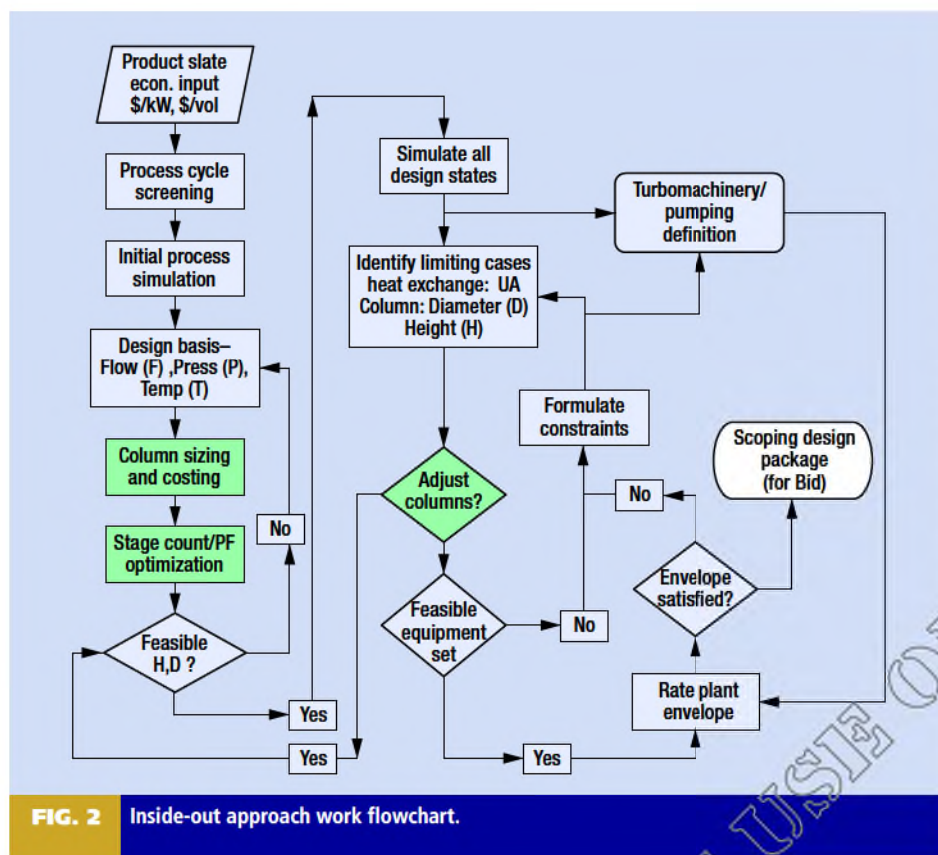

FIG. 2 Inside-out approach work flowchart.

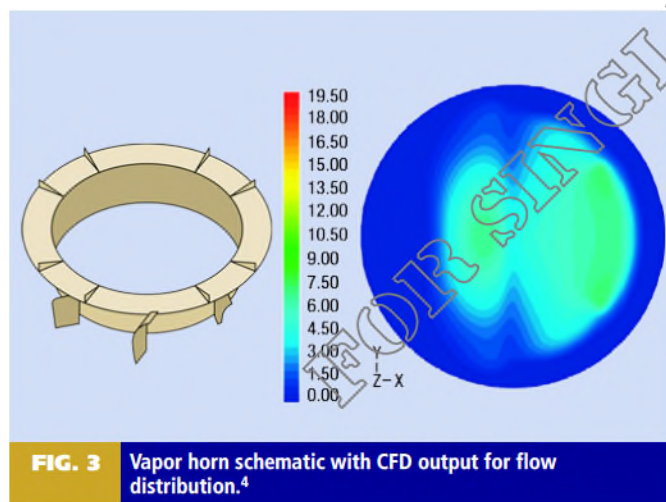

FIG. 3 Vapor horn schematic with CFD output for flow distribution.⁴

TABLE 1. Comparison between the base design and the design provided by the integrated design approach

	Example 1		Example 2	
	Base case	Integrated case	Base case	Integrated case
Crude, °API	20.1		10.5	
Base feed, bpd	25,000		250,000	
Design C-factor, ft/s	0.35		0.35	
Above Flash P drop, mmHg	13		15	
Operational mode	Damp, no strip steam		Damp, no strip steam	
Design margin, %	20	25	15	20
Diameter, ft	18	16	44.5	41

- Integrated heater and transfer line.

Table 1 summarizes two examples applying the inside-out approach. The optimized design reduced (or “right-sized”) the column diameter and provided increased production upside, while maintaining all other dimensions and satisfying the base capacity and yield requirements. Both designs used the same simulation topology.³ But the optimized case had an iterative step, as noted in Figs. 1 and 2, which factored in the performance of the internals equipment with respect to the crude characteristics and performance specifications.³

For example, the enhanced radial vapor horn allows increased lift velocities for a given entrainment rate. Fig. 3 shows a sketch of the vapor horn on the left with a computational fluid dynamics (CFD) output validating improved vapor distribution that has been field validated.⁴ By knowing what performance the device is capable of providing, the process designer has an opportunity to refine the design and optimize the associated equipment in the column as well.

Fig. 4 illustrates the relative benefit, compiled from numerous operations, of using an enhanced radial vapor horn vs. a standard inlet feed device. Applying the equipment’s specific features should be done during the initial stages of the design; in some cases, multiple iterations may be required to finalize a suitable design. Without timely expert input, a sub-optimal design is created since key data are not factored into the design. A more conservative design will result in greater capital and operating costs. However, future revamp opportunities are available but the economic impact of not optimally sizing the tower from the beginning should be fully evaluated.

Test-run data for Example 1 reveals that the balanced and optimized design has the column running at a continuous production of 32,000 bpd. The desired product quality is maintained while at very high C-factors (function of the features of the inlet vapor feed device and associated equipment) in the flash zone of 0.46–0.47 ft/s. C-factor has been defined as:

$$C_f = v_s \sqrt{\frac{\rho_v}{\rho_l - \rho_v}}$$

where v_s is the superficial velocity
 ρ_v is the vapor density
 ρ_l is the liquid density.

For Example 1, the approximate five-year net present value (NPV)—15% internal rate of return—is approximately C\$38 million (MM) based on actual capital savings from (~C\$20 MM in equipment/construction costs) a reduced column diameter, and also increased operating revenues (example: C\$5.3 MM/yr from 1,400 bpd at C\$8/bbl upgrade) from taking advantage of the increased capacity potential. These benefits would not have been possible if the equipment options were plugged in after the design had been set. Whether there are real benefits to be obtained can only be answered if the inside-out analysis is performed.

DISTILLATION

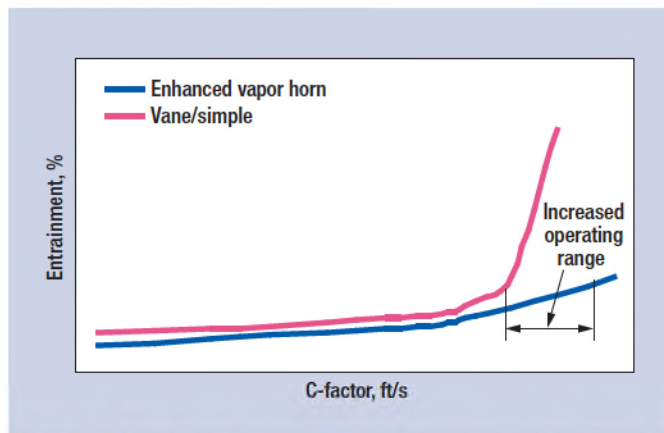

FIG. 4 Inlet feed device relative performance comparison.

Vacuum column designed for phased-production.

Adding to the vacuum column design optimization from the previous cases, this case study incorporates a phased-feed supply situation. Many oil sands upgrader operators implement phased upgrading production to match the output profile from bitumen deposits. An evaluation, as part of the vacuum-column design process, was done to determine if a vacuum unit could be sized for ultimate production while handling the initial lower feedrates. The base option was to have multiple smaller units constructed in phases to match the feed supply profile.

To provide the best possible scoping answer for a valid comparison with the base option, external equipment experts were brought in to determine the possibilities for going with an ultimate capacity column at the beginning. Fig. 5 shows the configuration of the vacuum column along with the portion of the column that included features to allow a phased approach to the match the feed supply.

Specific mechanical and process considerations were provided in the design to ensure reliable operation (e.g., prevent coking), mechanical integrity and a reasonable transition plan. Table 2 shows the difference in operation between Phases 1 and 2. The cost of reducing the effective cross-sectional area in Phase 1 was compared to the savings from reducing the pumparound flowrates in a staged design. The staged design incorporated the planned internals modifications in preparation for a step change in production. Work during a planned shutdown was minimized, accomplished on time without an incident, and the subsequent startup was smooth. During the early phases, unnecessary energy was not used due to the size of the column (e.g., appropriate pumparound rates to match column feed, not physical dimensions of column).

The NPV calculations incorporated the cost of one unit vs. two: the shutdown to make modifications and operating costs for two units. Many iterations and detailed calculations were needed to ensure that the right value to the benefits were included. Without collaboration with equipment experts, the one unit, staged design would not have been realized. The NPV from the one large column approach was significant enough to make a decision in favor of proceeding with the single vacuum unit approach.

Even in the situation where multiple units are chosen over one large unit, which is becoming more prevalent due to the ability to manage the project scope better, there is opportunity to improve these more standard designs by using the design expertise from equipment experts (as noted earlier).

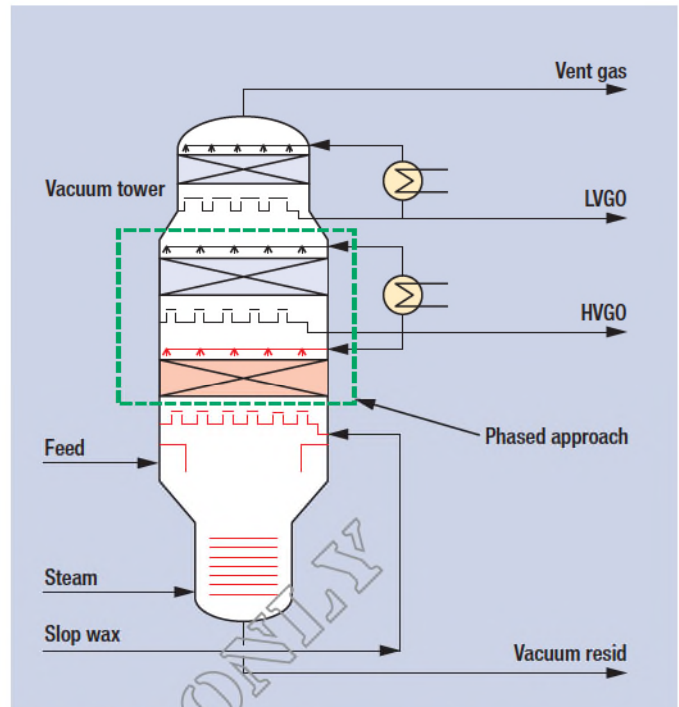

FIG. 5 Vacuum column design using phased approach.

TABLE 2. Approximate phased vacuum column design

	Phase 1	Phase 2
Feed, thousand bpd—normalized to 100 for Phase 1	100	160
Crude average, °API	7.2	
Effective tower X-section area, %	74	100
Wash-oil pumparound, bpd—normalized to 10,000 for Phase 1	10,000	14,000

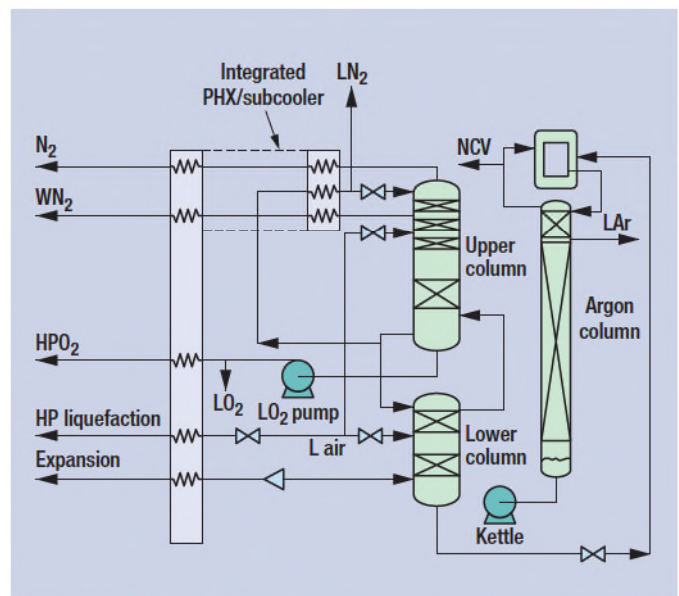

FIG. 6 Schematic of a typical air separation unit.

DISTILLATION

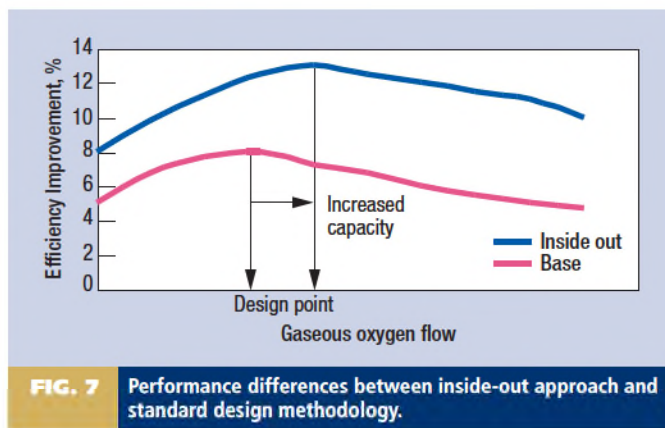

FIG. 7 Performance differences between inside-out approach and standard design methodology.

C₃ splitter grassroots design. This case study highlights a sensitivity to consider when using the inside-out design approach. For C₂ and C₃ splitters, the inside-out design approach is used extensively but creates a concern that the designer should address. Relying on a specific equipment expert throughout the process to provide performance characteristics may not provide the optimal solution. The example does show value from engaging multiple equipment experts to produce a suite of solutions for evaluation purposes.

Different internals exhibit different performance characteristics (efficiency and capacity) with the potential for different tower solutions. On a standard cross-flow tray at the vapor liquid interface, vapor travels upward interacting with liquid traveling in the horizontal direction. A counter-flow tray has the liquid essentially traveling downward with the vapor traveling upward at the interface. A standard cross-flow tray will typically provide greater efficiency and less capacity than a standard counter-flow tray.

The performance comparison between enhanced cross flow and enhanced counter flow is tougher to categorize. As a result, the process designer should provide a generic process scope to allow multiple third-party equipment experts to evaluate. When the designer follows the inside-out approach as noted in Fig. 2, various equipment experts can provide input after the design basis step to size the column and optimize the staging (noted in green in Fig. 2). The operator/designer will benefit from the choice of multiple “local” (provided by each equipment expert) optimum solutions. The iterative process will then provide the best choice given the original design basis.

As Table 3 illustrates, two different equipment experts will come up with different solutions due to the efficiency and capacity differences between specific equipment types. In this case, the biggest difference is the choice between one column and two columns with the obvious reduction in the project cost for a single column.

Other variables (e.g., pressure, reflux ratio and enhanced distillation trays) can be manipulated to meet the initial operating design specifications during the iterative step in the inside-out approach. A trade-off analysis between project and operating costs will result. The designer benefits from the choice of multiple feasible solutions that would otherwise not be possible during the downstream bid phase. If Solution B was only considered during the initial design phase, then the opportunity to provide a Solution A during the equipment bid phase is greatly reduced since the vessel design parameters have been set. The designer increases the chance for an optimal solu-

TABLE 3. Internals options for C₃ splitter grassroots design

Item	Solution A	Solution B
Feed, kgmol/hr/%propylene	1,100/48	
Ovhd pressure, psia	175	
C ₃ product, type/spec	Polymer grad/99.5%	
Operation	Heat pump, optional pasteurization	
Diameter, ft	16	
No. of columns	1	2
Type of standard tray	Cross flow	Counter flow
No. of actual trays	213	272

TABLE 4. ASU efficiency improvements—sequential vs. inside-out design

Item	Increase in efficiency	
	Sequential	Inside-Out
Trays to high-performance packing, %	3	4
Pre-purifier enhancements, %	0	1
Compression/booster enhancements, %	2	3
Next-generation heat exchangers, %	3	4
Total, %	8	12

tion by allowing equipment experts with unique equipment performance characteristics to engage in the column sizing/stage count optimization step.

Air separation unit. In response to increasing power costs, the primary cost input into the air separation unit (ASU)—a standard design as shown in Fig. 6, was evaluated to determine what additional capital could be afforded to improve the operating efficiency. The goal was a 10–12% efficiency improvement. There were numerous new enhancements (improved internals and heat transfer) that could be included in the new design. Table 4 lists some of the enhancements that could be used. A typical method in the design improvement process is to simply “plug in” the new technologies into the existing process design already available. The intent is to make the new technology fit the process and not the process fit the technology. This sequential method saves engineering time and can be easily input into a schedule with distinct milestones. But, it does not capture the full value from the enhancements developed. This example shows the benefits of the inside-out approach by starting with the enhanced equipment (inside), capturing the efficiency benefits and then building the simulation around (outside) the entire plant.

For a 600-tpd ASU with multiple products (liquid oxygen, gaseous oxygen, liquid nitrogen and liquid argon), Table 4 shows the efficiency gains from implementing various enhancements for each design approach.

For the same product flow, the integrated design approach provided a 50% increase in efficiency over the sequential approach, as noted in Table 4. Keeping the column diameters constant from the base case, the inside-out design approach provided a maximum efficiency improvement of 13% coupled with an unexpected, yet welcomed, higher capacity (~15% more production). Fig. 7 shows the performance comparison from the two design approaches relative to oxygen gas production. Assuming typical capital

DISTILLATION

(C\$17 MM base install, 15% IRR) and operating costs (C\$.05/kWh power), the added value from using the inside-out design approach is over C\$1 MM/yr per plant. The additional time/cost to perform the inside-out design is small compared to the value gained from an optimized design that can be replicated many times.

For the case of the next-generation heat exchangers, the lower pressure drop provided from the new exchanger technology can be fully realized in the inside-out approach. By incorporating this feature into the compression design and mass transfer stage count, the operator could capture the full value from the heat exchanger enhancement. In a sequential approach, the duties are provided as a target, and the heat exchanger expert designs to meet that target. **Result:** For the sequential approach, a 3% efficiency gain can be provided, which is an improvement. But it does not capture the full value from the new equipment design features as demonstrated by the inside-out approach (4–5% efficiency gain).

Outlook. The inside-out approach provides a successful methodology for a designer to provide an optimized design by incorporating appropriate equipment characteristics early into the design. The presented examples reinforce the value

of the inside-out approach while highlighting the value gained by engaging external-equipment experts into the early stages of the design process. Also, nearly any process from heavy-oil upgrading to polymer feed conditioning can benefit from this methodology. **HP**

LITERATURE CITED

- ¹ Dimian, A. C., *Integrated design and simulation of chemical processes*, Vol. 13, Elsevier Science, May 2003.
- ² Zeidan, A., "Consider a practical approach to vacuum unit revamps," *Hydrocarbon Processing*, January 2006, pp. 73–78.
- ³ Golden S., Shah, V. and Kovach III, J., "Improved flow sheet topology for petroleum refinery crude vacuum distillation simulation," Canadian Chemical Engineering Conference, Calgary, 1994.
- ⁴ Koch-Glitsch, Intalox Packed Tower Systems, Severe Services, Bulletin KGSS-1, 2003, Koch-Glitsch LP.



Darius Remesat is a chemical engineer working in process and business development for Koch-Glitsch Canada LP. Darius gained wide experience in operations, engineering, design, research & development, and sales while employed by Imperial Oil, Cyro Canada, Praxair and Koch-Glitsch. He holds a BS degree in engineering and management from McMaster University, an MBA from

Heriot-Watt University, a MS degree in engineering from the University of Calgary, and is near completion of a PhD from University of Calgary.

Eprinted and posted with permission to Koch-Glitsch, LP from *Hydrocarbon Processing*
August 2006 © 2015 Gulf Publishing Company

 **KOCH-GLITSCH®**

Koch-Glitsch, LP

4111 East 37th Street North • Wichita, KS 67220

Phone: (316) 828-5110 • Fax: (316) 828-7985 • www.koch-glitsch.com

For Koch-Glitsch trademark information, visit <http://www.koch-glitsch.com/trademarks>.

